

4.5-V TO 20-V INPUT, 6-A OUTPUT SYNCHRONOUS PWM SWITCHER WITH INTEGRATED FET (SWIFT™)

FEATURES

- 40 mΩ MOSFET Switch for High Efficiency at 6-A (7.5 Peak) Output Current
- Uses External Lowside MOSFET
- Output Voltage Adjustable Down to 0.891 V With 1% Accuracy
- Synchronizes to External Clock
- 180° Out of Phase Synchronization
- Wide PWM Frequency—Fixed 250 kHz, 500 kHz or Adjustable 250 kHz to 700 kHz
- Adjustable Slow Start
- Adjustable Undervoltage Lockout
- Load Protected by Peak Current Limit and Thermal Shutdown
- 16-Pin TSSOP PowerPAD™ Package
- SWIFT Documentation Application Notes, and Design Software: www.ti.com/swift

APPLICATIONS

- Industrial and Commercial Low Power Systems
- LCD Monitors and TVs
- Computer Peripherals
- Point of Load Regulation for High-Performance DSPs, FPGAs, ASICs and Microprocessors

DESCRIPTION

The TPS54550 is a medium output current synchronous buck PWM converter with an integrated high-side MOSFET and a gate driver for an low-side external MOSFET. Features include a high-performance voltage error amplifier that enables maximum performance under transient conditions and flexibility in choosing the output filter inductors and capacitors. The TPS54550 has an undervoltage lockout circuit to prevent start-up until the input voltage reaches 4.5 V; a slow-start circuit to limit in-rush currents; and a power good output to indicate valid output conditions. The synchronization feature is configurable as either an input or an output for easy 180° out of phase synchronization.

The TPS54550 device is available in a thermally-enhanced 16-pin TSSOP (PWP) PowerPAD™ package. TI provides evaluation modules and the SWIFT™ Designer software tool to aid in quickly achieving high-performance power supply designs to meet aggressive equipment development cycles.

Simplified Schematic

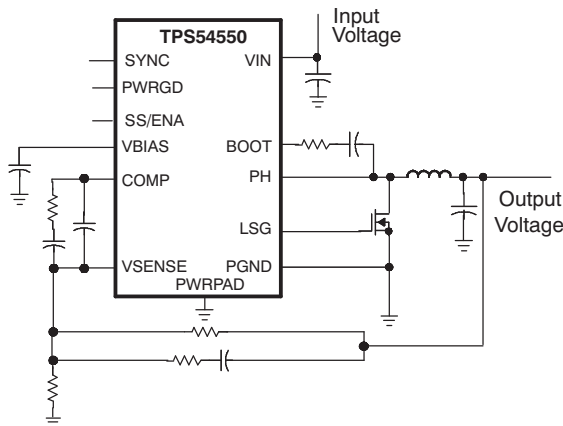

**EFFICIENCY
vs
OUTPUT CURRENT**

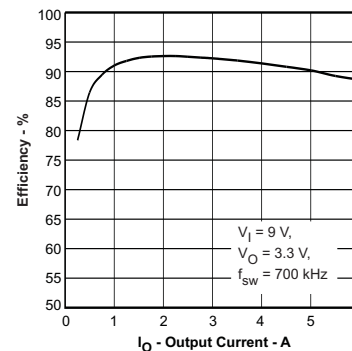

Please be aware that an important notice concerning availability, standard warranty, and use in critical applications of Texas Instruments semiconductor products and disclaimers thereto appears at the end of this data sheet.

SWIFT, PowerPAD are trademarks of Texas Instruments.
All other trademarks are the property of their respective owners.



These devices have limited built-in ESD protection. The leads should be shorted together or the device placed in conductive foam during storage or handling to prevent electrostatic damage to the MOS gates.

ORDERING INFORMATION

T _j	OUTPUT VOLTAGE	PACKAGE	PART NUMBER ⁽¹⁾
–40°C to +125°C	Adjustable to 0.891 V	Plastic HTSSOP (PWP)	TPS54550PWP ⁽²⁾

- (1) For the most current package and ordering information, see the Package Option Addendum at the end of this document, or see the TI website at www.ti.com.
- (2) The PWP package is also available taped and reeled. Add an R suffix to the device type (i.e., TPS54550PWPR).

PACKAGE DISSIPATION RATINGS⁽¹⁾

PACKAGE	THERMAL IMPEDANCE JUNCTION-TO-AMBIENT	T _A = +25°C POWER RATING	T _A = +70°C POWER RATING	T _A = +85°C POWER RATING
16-Pin PWP with solder ⁽²⁾	40.1°C/W	2.49	1.37	1.00

- (1) See [Figure 22](#) for power dissipation curves.
- (2) Test Board Conditions
- 3 inch x 3 inch
 - Thickness: 0.062 inch
 - 2 PCB layers
 - 2 oz. Copper
 - See [Figure 26](#), [Figure 27](#) and [TPS54550 evaluation module user's guide](#) for layout suggestions.

ABSOLUTE MAXIMUM RATINGS⁽¹⁾

Over operating free-air temperature range unless otherwise noted

		UNIT	
V _I	Input voltage range	VIN	–0.3 V to 21.5 V
		VSENSE	–0.3 V to 8.0 V
		UVLO	–0.3 V to 8.0 V
		SYNC	–0.3 V to 4.0 V
		SSENA	–0.3 V to 4.0 V
		BOOT	VI(PH) + 8.0 V
V _O	Output voltage range	VBIAS	–0.3 to 8.5 V
		LSG	–0.3 to 8.5 V
		SYNC	–0.3 to 4.0 V
		RT	–0.3 to 4.0 V
		PWRGD	–0.3 to 6.0 V
		COMP	–0.3 to 4.0 V
		PH	–1.5 V to 22 V
I _O	Source current	PH	Internally limited (A)
		LSG (Steady State Current)	10 mA
		COMP, VBIAS	3 mA
I _S	Sink current	SYNC	5 mA
		LSG (Steady State Current)	100 mA
		PH (Steady State Current)	500 mA
		COMP	3 mA
		SSENA, PWRGD	10 mA
		Voltage differential	AGND to PGND
T _J	Junction temperature	+150°C	
T _{stg}	Storage temperature	–65°C to +150°C	
Lead temperature 1,6 mm (1/16 inch) from case for 10 seconds		+260°C	

(1) Stresses beyond those listed under absolute maximum ratings may cause permanent damage to the device. These are stress ratings only, and functional operation of the device at these or any other conditions beyond those indicated under recommended operating conditions is not implied. Exposure to absolute-maximum-rated conditions for extended periods may affect device reliability.

ELECTROSTATIC DISCHARGE

			MIN	TYP	MAX	UNIT
Human Body Model	HBM	JESD22-A114			1.5	kV
Charged Device Model	CDM	JESD22-C101			1.5	kV

RECOMMENDED OPERATING CONDITIONS

		MIN	NOM	MAX	UNIT
V _I	Input voltage range	4.5		20	V
T _J	Operating junction temperature	–40		+125	°C

ELECTRICAL CHARACTERISTICST_J = –40°C to +125°C, V_{IN} = 4.5 V to 20 V (unless otherwise noted)

PARAMETER		TEST CONDIIONS	MIN	TYP	MAX	UNIT
SUPPLY CURRENT						
I _Q	Quiescent current	Operating current, PH pin open, No external low-side MOSFET, RT = Hi-Z		10.3		mA
		Shutdown, SSEN _A = 0 V		1.1		mA
V _{IN}	Start threshold voltage			4.32	4.49	V
	Stop threshold voltage		3.69	3.97		V
	Hysteresis			350		mV
UNDER VOLTAGE LOCK OUT (UVLO PIN)						
UVLO	Start threshold voltage			1.20	1.24	V
	Stop threshold voltage		1.02	1.10		V
	Hysteresis			100		mV
BIAS VOLTAGE (VBIAS PIN)						
VBIAS	Output voltage	I _{VBIAS} = 1 mA, V _{IN} ≥ 12 V	7.5	7.8	8.0	V
		I _{VBIAS} = 1 mA, V _{IN} = 4.5 V	4.4	4.47	4.5	
REFERENCE SYSTEM ACCURACY						
Reference voltage		T _J = 25°C	0.888	0.891	0.894	V
			0.882	0.891	0.899	V
OSCILLATOR (RT PIN)						
Internally set PWM switching frequency		RT grounded	200	250	300	kHz
		RT open	400	500	600	
Externally set PWM switching frequency		RT = 100 kΩ (1% resistor to AGND)	425	500	575	kHz
FALLING EDGE TRIGGERED BIDIRECTIONAL SYNC SYSTEM (SYNC PIN)						
SYNC out low-to-high rise time (10%/90%) ⁽¹⁾		25 pF to ground		200	500	ns
SYNC out high-to-low fall time (90%/10%) ⁽¹⁾		25 pF to ground		5	10	ns
Falling edge delay time ⁽¹⁾		Delay from rising edge to rising edge of PH pins		180		°
Minimum input pulsewidth ⁽¹⁾		RT = 100 kΩ		100		ns
Delay (falling edge SYNC to rising edge PH) ⁽¹⁾		RT = 100 kΩ		360		ns
SYNC out high level voltage		50 kΩ resistor to ground, No pull-up resistor	2.5			V
SYNC out low level voltage					0.6	V
SYNC in low level threshold			0.8			V
SYNC in high level threshold					2.3	V
SYNC in frequency range ⁽¹⁾		Percentage of programmed frequency	–10		+10	%
			225		770	kHz
FEED-FORWARD MODULATOR (INTERNAL SIGNAL)						
Modulator gain		V _{IN} = 12 V, T _J = +25°C		8		V/V
Modulator gain variation			–25		+25	%
Minimum controllable ON time ⁽¹⁾				180		ns
Maximum duty factor ⁽¹⁾		V _{IN} = 4.5 V	80%	86%		
ERROR AMPLIFIER (VSENSE and COMP PINS)						
Error amplifier open-loop voltage gain ⁽¹⁾			60	80		dB
Error amplifier unity gain bandwidth ⁽¹⁾			1.0	2.8		MHz
Input bias current, VSENSE pin					500	nA
COMP	Output voltage slew rate (symmetric) ⁽¹⁾			1.5		V/μs

(1) Specified by design, not production tested.

ELECTRICAL CHARACTERISTICS (continued)
 $T_J = -40^{\circ}\text{C}$ to $+125^{\circ}\text{C}$, $V_{IN} = 4.5\text{ V}$ to 20 V (unless otherwise noted)

PARAMETER		TEST CONDITIOINS	MIN	TYP	MAX	UNIT
Slow Start/ENABLE (SSENA PIN)						
Disable low level input voltage					0.5	V
Internal slow-start time (10% to 90%)		$f_s = 250\text{ kHz}$, RT = ground ⁽¹⁾		4.6		ms
		$f_s = 500\text{ kHz}$, RT = Hi-Z ⁽¹⁾		2.3		
Pull-up current source			1.8	5	10	μA
Pull-down MOSFET		$I_{II}(\text{SSENA}) = 1\text{ mA}$		0.1		V
POWER GOOD(PWRGD PIN)						
Power good threshold		Rising voltage		97%		
Rising edge delay ⁽¹⁾		$f_s = 250\text{ kHz}$		4		ms
		$f_s = 500\text{ kHz}$		2		
PWRGD	Output saturation voltage	$I_{\text{sink}} = 1\text{ mA}$, $V_{IN} > 4.5\text{ V}$		0.05		V
	Output saturation voltage	$I_{\text{sink}} = 100\ \mu\text{A}$, $V_{IN} = 0\text{ V}$		0.76		V
	Open drain leakage current	Voltage on PWRGD = 6 V			3	μA
CURRENT LIMIT						
Current limit		$V_{IN} = 12\text{ V}$	7.5	8.5	9.5	A
Current limit Hiccup Time ⁽¹⁾		$f_s = 500\text{ kHz}$		4.5		ms
THERMAL SHUTDOWN						
Thermal shutdown trip point				165		$^{\circ}\text{C}$
Thermal shutdown hysteresis ⁽¹⁾				7		$^{\circ}\text{C}$
LOW SIDE MOSFET DRIVER (LSG PIN)						
Turn on rise time, (10%/90%) ⁽¹⁾		$V_{IN} = 4.5\text{ V}$, Capacitive load = 1000 pF		15		ns
		$V_{IN} = 8\text{ V}$, Capacitive load = 1000 pF		12		
Dead-time ⁽¹⁾		$V_{IN} = 12\text{ V}$		60		ns
Driver ON resistance		$V_{IN} = 4.5\text{ V}$ sink/source		7.5		Ω
		$V_{IN} = 12\text{ V}$ sink/source		5		
OUTPUT POWER MOSFETS (PH PIN)						
Phase node voltage when disabled		DC conditions and no load, SSENA = 0 V		0.5		V
Voltage drop, low-side FET and diode		$V_{IN} = 4.5\text{ V}$, $I_{dc} = 100\text{ mA}$		1.13	1.42	V
		$V_{IN} = 12\text{ V}$, $I_{dc} = 100\text{ mA}$		1.08	1.38	
$r_{DS(ON)}$	High side power MOSFET switch ⁽²⁾	$V_{IN} = 4.5\text{ V}$, BOOT-PH = 4.5 V, $I_O = 0.5\text{ A}$		60		m Ω
		$V_{IN} = 12\text{ V}$, BOOT-PH = 8 V, $I_O = 0.5\text{ A}$		40		

(1) Specified by design, not production tested.

 (2) Resistance from V_{IN} to PH pins.

PIN ASSIGNMENTS

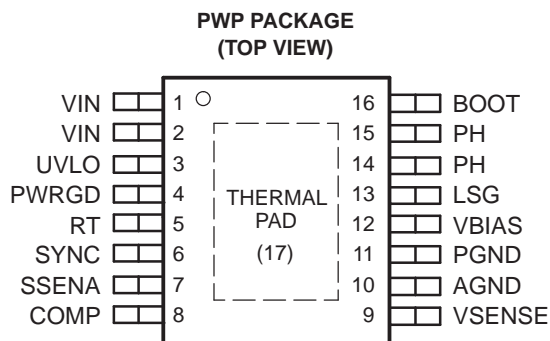

NOTE: If there is not a Pin 1 indicator, turn device to enable reading the symbol from left to right. Pin 1 is at the lower left corner of the device.

Terminal Functions

TERMINAL NO.	NAME	DESCRIPTION
1, 2	VIN	Input supply voltage, 4.5 V to 20 V. Must bypass with a low ESR 10- μ F ceramic capacitor.
3	UVLO	Undervoltage lockout pin. Connecting an external resistive voltage divider from VIN to the pin will override the internal default VIN start and stop thresholds.
4	PWRGD	Power good output. Open drain output. A low on the pin indicates that the output is less than the desired output voltage. There is an internal rising edge filter on the output of the PWRGD comparator.
5	RT	Frequency setting pin. Connect a resistor from RT to AGND to set the switching frequency. Connecting the RT pin to ground or floating will set the frequency to an internally preselected frequency.
6	SYNC	Bidirectional synchronization I/O pin. SYNC pin is an output when the RT pin is floating or connected low. The output is a falling edge signal out of phase with the rising edge of PH. SYNC may be used as an input to synchronize to a system clock by connecting to a falling edge signal when an RT resistor is used. See 180 Degrees Out of Phase Synchronization Operation in the Application Information .
7	SENA	Slow Start/Enable. The SENA pin is a dual function pin which provides a logic enable/disable and a slow start time set. Below 0.5 V, the device stops switching. Float pin to enable. Capacitor to ground adjusts the slow start time. See Extending Slow Start Time section.
8	COMP	Error amplifier output. Connect frequency compensation network from COMP to VSENSE pins.
9	VSENSE	Inverting node error amplifier.
10	AGND	Analog ground—internally connected to the sensitive analog ground circuitry. Connect to PGND and PowerPAD.
11	PGND	Power Ground—Noisy internal ground. Return currents from the LSG driver output return through the PGND pin. Connect to AGND and PowerPAD.
12	VBIAS	Internal 8.0 V bias voltage. A 1.0 μ F ceramic bypass capacitance is required on the VBIAS pin.
13	LSG	Gate drive for low-side MOSFET. Connect gate of n-channel MOSFET.
14, 15	PH	Phase node—Connect to external L-C filter.
16	BOOT	Bootstrap for high-side gate driver. Connect 24 Ω and 0.1 μ F ceramic capacitor from BOOT to PH pins.
17	PowerPAD	PGND and AGND pins must be connected to the exposed pad for proper operation. See Figure 26 for an example PCB layout.

FUNCTIONAL BLOCK DIAGRAM

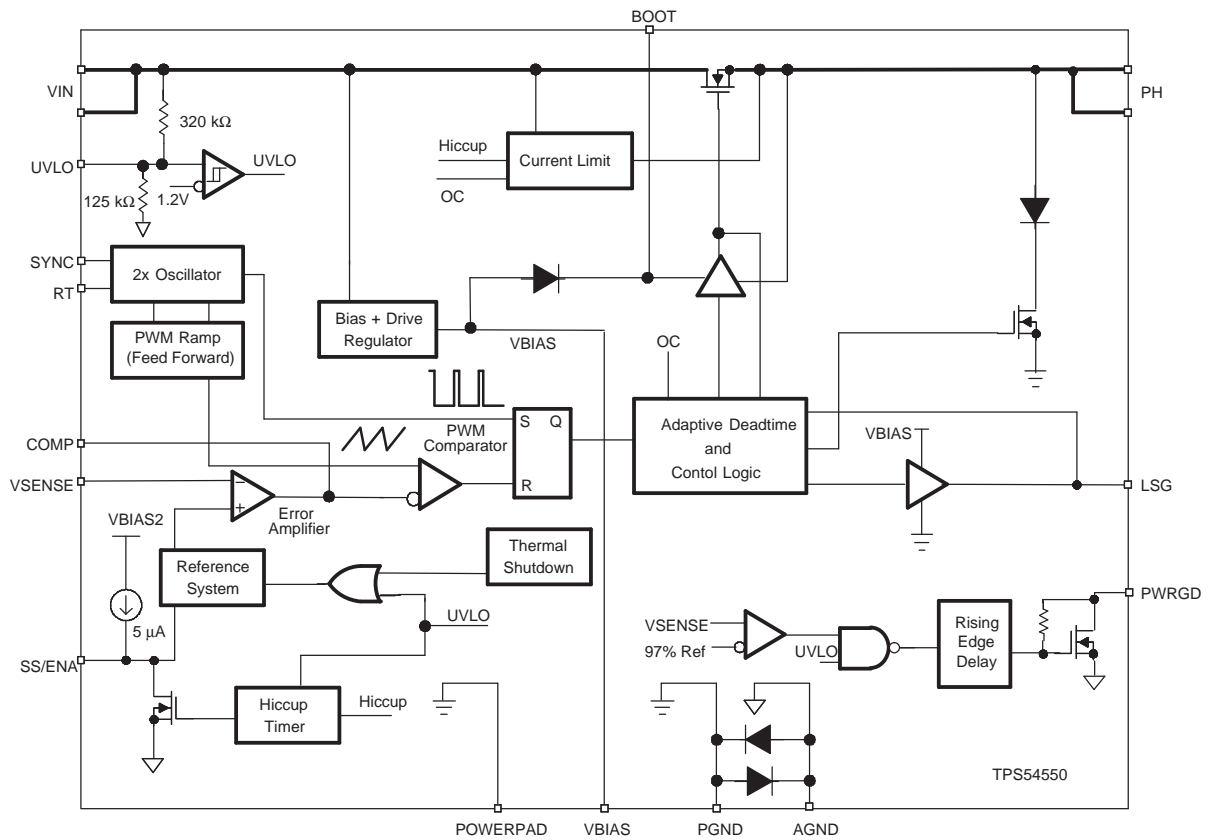

DETAILED DESCRIPTION

Undervoltage Lockout (UVLO)

The undervoltage lockout (UVLO) system has an internal voltage divider from VIN to AGND. The defaults for the start/stop values are labeled VIN and given in Table 1. The internal UVLO threshold can be overridden by placing an external resistor divider from VIN to ground. The internal divider values are approximately 320 kΩ for the high-side resistor and 125 kΩ for the low-side resistor. The divider ratio (and therefore the default start/stop values) is quite accurate, but the absolute values of the internal resistors may vary as much as 15%. If high accuracy is required for an externally adjusted UVLO threshold, select lower value external resistors to set the UVLO threshold. Using a 1-kΩ resistor for the low-side resistor R2 (see Figure 1) is recommended. Under no circumstances should the UVLO pin be connected directly to VIN.

Table 1. Start/Stop Voltage Threshold

	START VOLTAGE THRESHOLD	STOP VOLTAGE THRESHOLD
VIN (Default)	4.49	3.69
UVLO	1.24	1.02

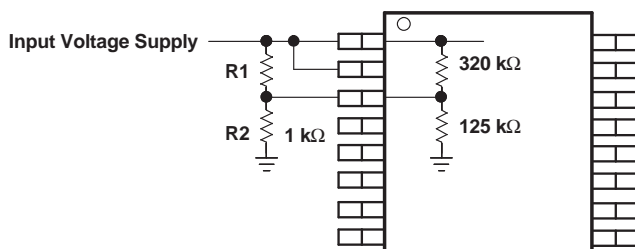

Figure 1. Circuit Using External UVLO Function

The equations for selecting the UVLO resistors are:

$$R1 = \frac{VIN(start) \times 1\text{ k}\Omega}{1.24\text{ V}} - 1\text{ k}\Omega \quad (1)$$

$$VIN(stop) = \frac{(R1 + 1\text{ k}\Omega) \times 1.02\text{ V}}{1\text{ k}\Omega} \quad (2)$$

For applications which require an undervoltage lock out (UVLO) threshold greater than 4.49 V, external resistors may be implemented (see Figure 1) to adjust the start voltage threshold. For example, an application needing an UVLO start voltage of approximately 7.8 V using Equation 1, R1 is calculated to the nearest standard resistor value of 5.36 kΩ. Using Equation 2, the input voltage stop threshold is calculated as 6.48 V.

Slow Start Enable (SSENA) and Internal Slow Start

Once the SSENA pin voltage exceeds 0.5 V, the TPS54550 starts operation. The TPS54550 has an internal digital slow start that ramps the reference voltage to its final value in 1150 switching cycles. The internal slow start time (10% - 90%) is approximated by the following expression:

$$T_{SS_INTERNAL}(ms) = \frac{1.15k}{f_s(kHz)} \quad (3)$$

Once the TPS54550 device is in normal regulation, the SSENA pin is high. If the SSENA pin is pulled below the stop threshold of 0.5 V, switching stops and the internal slow start resets. If an application requires the TPS54550 to be disabled, use open drain or open collector output logic to interface to the SSENA pin (see Figure 2). The SSENA pin has an internal pull-up current source. Do not use external pull-up resistors.

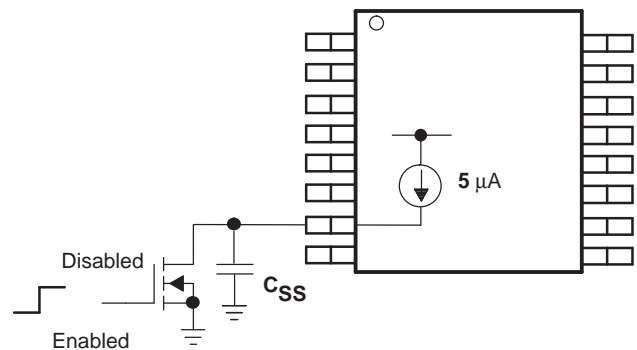

Figure 2. Interfacing to the SSENA Pin

Extending Slow Start Time

In applications that use large values of output capacitance, there may be a need to extend the slow start time to prevent the startup current from tripping the current limit. The current limit circuit is designed to disable the high-side MOSFET and reset the internal voltage reference for a short amount of time when the high-side MOSFET current exceeds the current limit threshold. If the output capacitance and load current cause the startup current to exceed the current limit threshold, the power supply output will not reach the desired output voltage. To extend the slow start time and to reduce the startup current, an external capacitor can be added to the SSENA pin. The slow start capacitance is calculated using the following equation:

$$C_{SS}(\mu F) = 5.55 \times 10^{-3} T_{SS}(ms)$$

Switching Frequency (RT)

The TPS54550 has an internal oscillator that operates at twice the PWM switching frequency. The internal oscillator frequency is controlled by the RT pin. Grounding the RT pin sets the PWM switching frequency to a default frequency of 250 kHz. Floating the RT pin sets the PWM switching frequency to 500kHz.

Connecting a resistor from RT to AGND sets the frequency according to Equation 4 (see Figure 13).

$$RT(k\Omega) = \frac{46000}{f_s(kHz) - 35.9} \quad (4)$$

The RT pin controls the SYNC pin functions. If the RT pin is floating or grounded, SYNC is an output. If the switching frequency has been programmed using a resistor from RT to AGND, then SYNC functions as an input.

The internal voltage ramp charging current increases linearly with the set frequency and keeps the feed forward modulator constant ($K_m = 8$) regardless of the frequency set point.

Table 2. Switching Frequency, SYNC and RT Pins

SWITCHING FREQUENCY	SYNC PIN	RT PIN
250 kHz, internally set	Generates SYNC output signal	AGND
500 kHz, internally set	Generates SYNC output signal	Float
Externally set to 250 kHz to 700 kHz	Terminate to quiet ground with 10-kΩ resistor.	R = 215 kΩ to 69 kΩ
Externally synchronized frequency	Synchronization Signal	Use 110 kΩ when RT floats and 237 kΩ when RT is grounded and using the sync out signal of another TPS54550. Set RT resistor equal to 90% to 110% of external synchronization frequency.

180° Out of Phase Synchronization (SYNC)

The SYNC pin is configurable as an input or as an output, per the description in the previous section. When operating as an input, the SYNC pin is a falling-edge triggered signal (see Figure 3 and Figure 4). When operating as an output, the signal's falling edge is approximately 180° out of phase with the rising edge of the PH pins. Thus, two TPS54550 devices operating in a system can share an input capacitor and draw ripple current at twice the frequency of a single unit.

When operating the two TPS54550 devices 180° out of phase, the total RMS input current is reduced, decreasing the amount of input capacitance needed and increasing efficiency.

When synchronizing a TPS54550 to an external signal, the timing resistor on the RT pin must be set so that the oscillator is programmed to run at 90% to 110% of the synchronization frequency.

NOTE: Do not use synchronization input for designs with output voltages > 10 V.

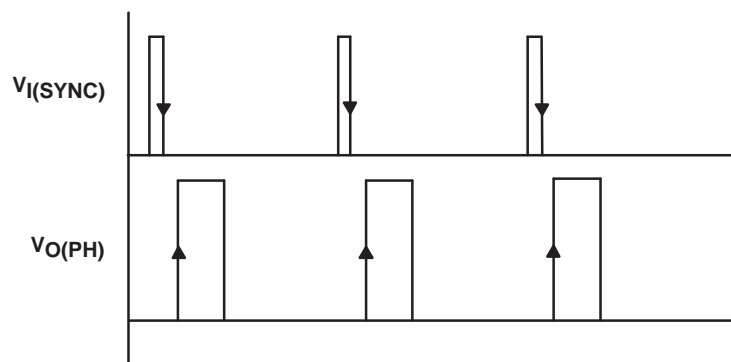

Figure 3. SYNC Input Waveform

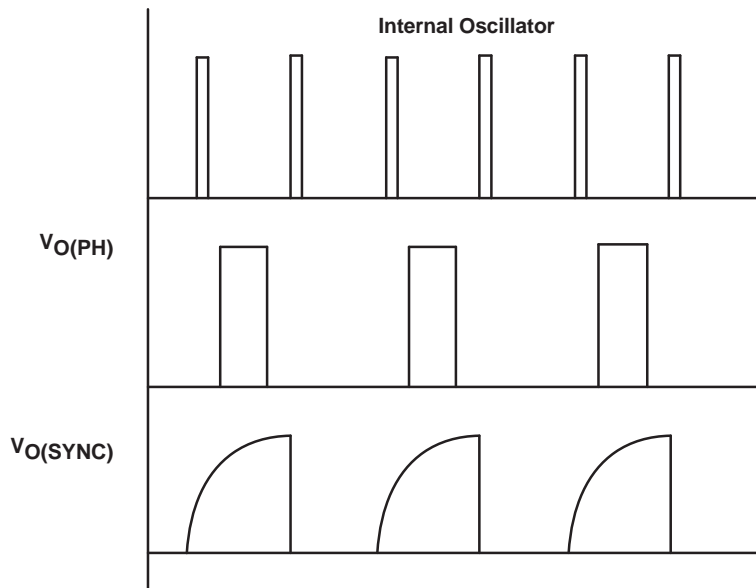

Figure 4. SYNC Output Waveform

Power Good (PWRGD)

The VSENSE pin is compared to an internal reference signal. If the VSENSE is greater than 97% and no other faults are present, the PWRGD pin presents a high impedance. A low on the PWRGD pin indicates a fault. The PWRGD pin has been designed to provide a weak pull-down and indicates a fault even when the device is unpowered. If the TPS54550 has power and has any fault flag set, the TPS54550 indicates the power is not good by driving the PWRGD pin low. The following events, alone or in combination, indicate power is not good:

- VSENSE pin out of bounds
- Overcurrent
- Thermal shutdown
- UVLO undervoltage
- Input voltage not present (weak pull-down)
- Slow-starting
- VBIAS voltage is low

Once the PWRGD pin presents a high impedance (i.e., power is good), a VSENSE pin out of bounds condition forces PWRGD pin low (i.e., power is bad) after a time delay. This time delay is a function of the switching frequency and is calculated using Equation 5:

$$T_{\text{delay}} = \frac{1000}{f_s(\text{kHz})} \text{ ms} \quad (5)$$

Bias Voltage (VBIAS)

The VBIAS regulator provides a stable supply for the internal analog circuits and the low-side gate driver.

Up to 1 mA of current can be drawn for use in an external application circuit. The VBIAS pin must have a bypass capacitor value of 1.0 μF . X7R or X5R grade dielectric ceramic capacitors are recommended because of the stable characteristics over temperature.

Bootstrap Voltage (BOOT)

The BOOT capacitor obtains its charge cycle by cycle from the VBIAS capacitor. A capacitor and small value resistor from the BOOT pin to the PH pins are required for operation. The bootstrap connection for the high-side driver must have a bypass capacitor of 0.1 μF and 24- Ω resistor.

Error Amplifier

The VSENSE pin is the error amplifier inverting input. The error amplifier is a true voltage amplifier with 1.5 mA of drive capability with a minimum of 60 dB of open-loop voltage gain and a unity gain bandwidth of 2 MHz.

Voltage Reference

The voltage reference system produces a precision reference signal by scaling the output of a temperature stable bandgap circuit. During production testing, the bandgap and scaling circuits are trimmed to produce 0.891 V at the output of the error amplifier, with the amplifier connected as a voltage follower. The trim procedure improves the regulation, since it cancels offset errors in the scaling and error amplifier circuits.

PWM Control and Feed Forward

Signals from the error amplifier output, oscillator, and current limit circuit are processed by the PWM control logic. Referring to [the internal block diagram](#), the control logic includes the PWM comparator, PWM latch, and the adaptive dead-time control logic. During steady-state operation below the current limit threshold, the PWM comparator output and oscillator pulse train alternately reset and set the PWM latch.

Once the PWM latch is reset, the low-side driver and integrated pull-down MOSFET remain on for a minimum duration set by the oscillator pulse width. During this period, the PWM ramp discharges rapidly to the valley voltage. When the ramp begins to charge back up, the low-side driver turns off and the high-side FET turns on. The peak PWM ramp voltage varies inversely with input voltage to maintain a constant modulator and power stage gain of 8 V/V.

As the PWM ramp voltage exceeds the error amplifier output voltage, the PWM comparator resets the latch, thus turning off the high-side FET and turning on the low-side FET. The low-side driver remains on until the next oscillator pulse discharges the PWM ramp.

During transient conditions, the error amplifier output can be below the PWM ramp valley voltage or above the PWM peak voltage. If the error amplifier is high, the PWM latch is never reset and the high-side FET remains on until the oscillator pulse signals the control logic to turn the high-side FET off and the internal low-side FET and driver on. The device operates at its maximum duty cycle until the output voltage rises to the regulation set point, setting VSENSE to approximately the same voltage as the internal voltage reference. If the error amplifier output is low, the PWM latch is continually reset and the high-side FET does not turn on. The internal low-side FET and low-side driver remain on until the VSENSE voltage decreases to a range that allows the PWM comparator to change states. The TPS54550 is capable of sinking current through the external low-side FET until the output voltage reaches the regulation set point.

The minimum on time is designed to be 180 ns. During the internal slow-start interval, the internal reference ramps from 0 V to 0.891 V. During the initial slow-start interval, the internal reference voltage is very small, resulting in a couple of skipped pulses because the minimum on time causes the actual output voltage to be slightly greater than the preset output voltage until the internal reference ramps up.

Dead-time Control

Adaptive dead-time control prevents shoot-through current from flowing in the integrated high-side MOSFET and the external low-side MOSFET during the switching transitions by actively controlling the turn on times of the drivers. The high-side driver does not turn on until the voltage at the gate of the low-side MOSFET is below 1 V. The low-side driver does not turn on until the voltage at the gate of the high-side MOSFET is below 1 V.

Low Side Gate Driver (LSG)

LSG is the output of the low-side gate driver. The 100-mA MOSFET driver is capable of providing gate drive for most popular MOSFETs suitable for this application. Use the SWIFT Designer Software Tool to find the most appropriate MOSFET for the application. Connect the LSG pin directly to the gate of the low-side MOSFET. Do not use a gate resistor as the resulting turn-on time may be too slow.

Thermal Shutdown

The device uses the thermal shutdown to turn off the MOSFET drivers and controller if the junction temperature exceeds +165°C. The device is restarted automatically when the junction temperature decreases to 7°C below the thermal shutdown trip point and starts up under control of the slow-start circuit.

Overcurrent Protection

Overcurrent protection is implemented by sensing the drain-to-source voltage across the high-side MOSFET and compared to a voltage level which represents the overcurrent threshold limit. If the drain-to-source voltage exceeds the overcurrent threshold limit for more than 100 ns, the high-side MOSFET is disabled, the SSEN pin is pulled low, and the internal digital slow-start is reset to 0 V. SSEN is held low for approximately the time that is calculated by [Equation 6](#):

$$T_{\text{HICCUP}}(\text{ms}) = \frac{2250}{f_s(\text{kHz})} \quad (6)$$

Once the hiccup time is complete, the SSEN pin is released and the converter initiates the internal slow-start.

Setting the Output Voltage

The output voltage of the TPS54550 can be set by feeding back a portion of the output to the VSENSE pin using a resistor divider network. In the application circuit of [Figure 29](#), this divider network is comprised of resistors R1 and R2. To calculate the resistor values to generate the required output voltage use the following equation:

$$R2 = \frac{R1 \times 0.891}{V_o - 0.891} \quad (7)$$

Start with a fixed value of R1 and calculate the required R2 value. Assuming a fixed value of 10 k Ω for R1, the following table gives the appropriate R2 value for several common output voltages:

OUTPUT VOLTAGE (V)	R2 VALUE (k Ω)
1.2	28.7
1.5	14.7
1.8	9.76
2.5	5.49
3.3	3.74

Output Voltage Limitations

Due to the internal design of the TPS54550 there are both upper and lower output voltage limits for any given input voltage. Additionally, the lower boundary of the output voltage set point range also depends on operating frequency. The upper limit of the output voltage set point is constrained by the maximum duty cycle of the device and is shown in [Figure 12](#). The lower limit is constrained by the minimum controllable on time, which may be as high as 220 ns. The approximate minimum output voltage for a given input voltage and range of operating frequencies is shown in [Figure 8](#), while the maximum operating frequency versus input voltage for some common output voltages is shown in [Figure 10](#).

The curves shown in these two figures are valid for output currents greater than 0.5 A. As output currents decrease towards no load (0 A), the minimum output voltage decreases. For applications where the load current is less than 100 mA, the curves shown in [Figure 9](#) and [Figure 11](#) are applicable. All of the data plotted in these curves are approximate and take into account a possible 20% deviation in actual operating frequency relative to the intended set point.

TYPICAL CHARACTERISTICS

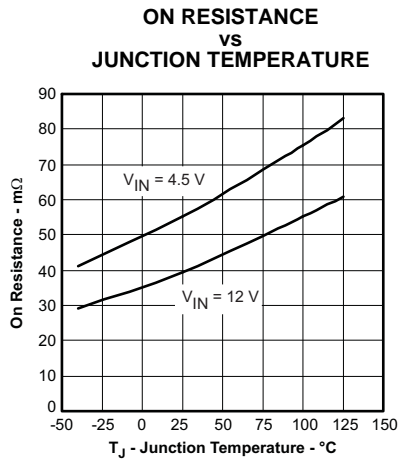

Figure 5.

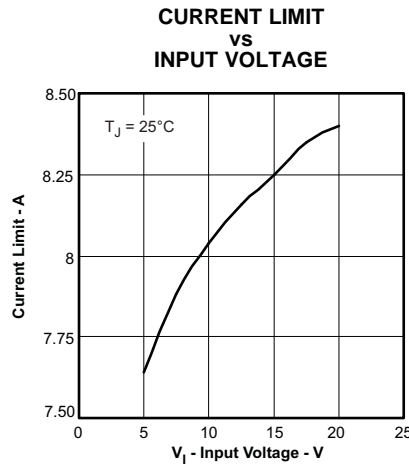

Figure 6.

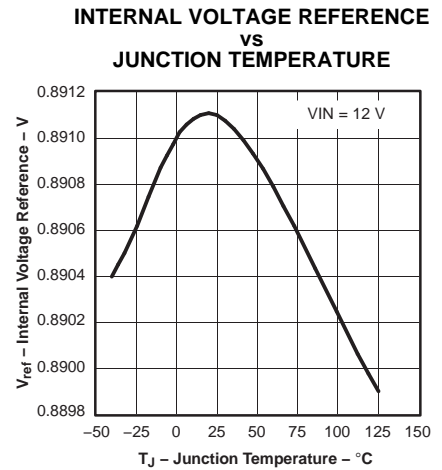

Figure 7.

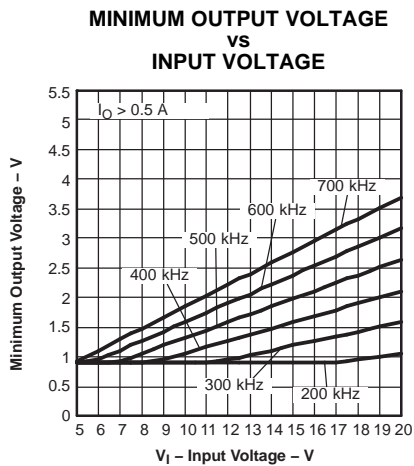

Figure 8.

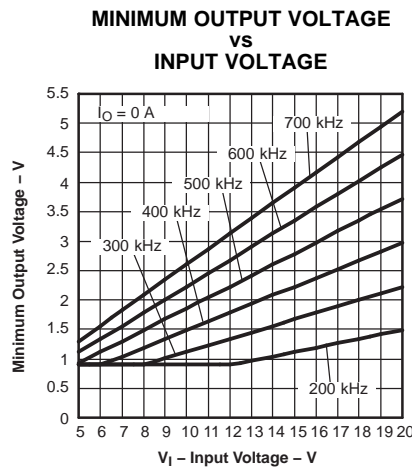

Figure 9.

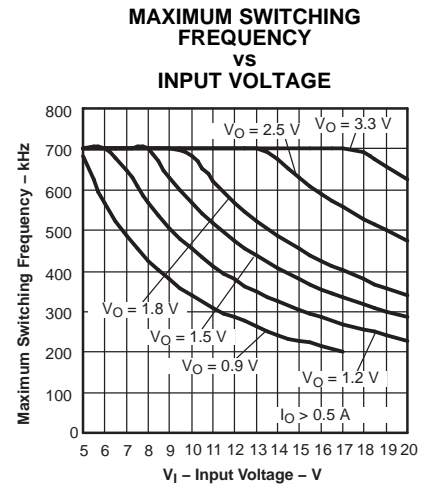

Figure 10.

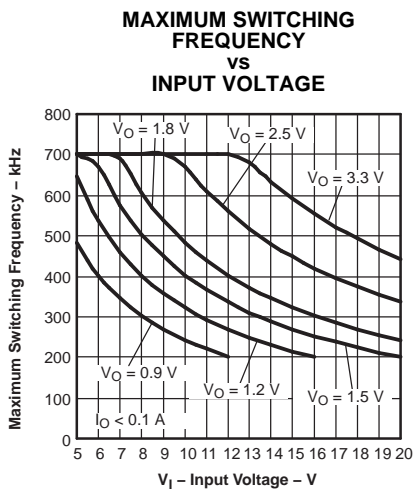

Figure 11.

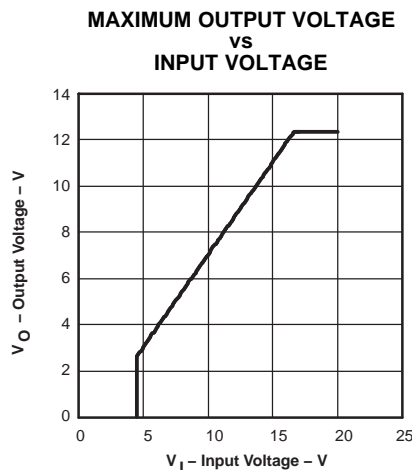

Figure 12.

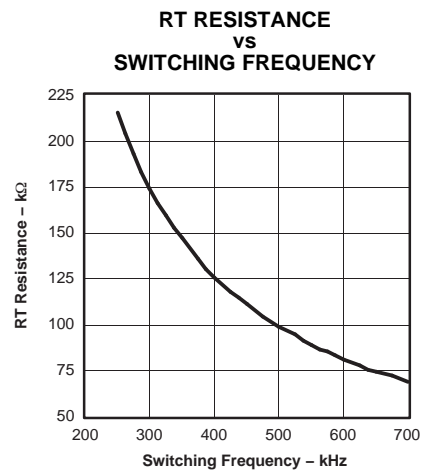

Figure 13.

TYPICAL CHARACTERISTICS (continued)

VIN (UVLO) START AND STOP
VS
FREE-AIR TEMPERATURE

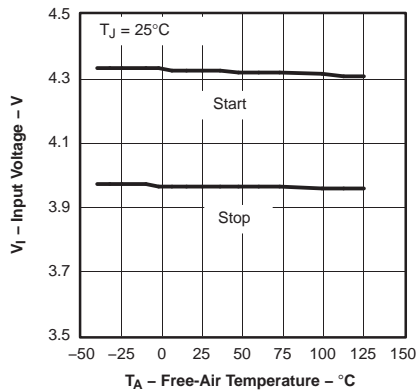

Figure 14.

ENABLED SUPPLY CURRENT
VS
INPUT VOLTAGE

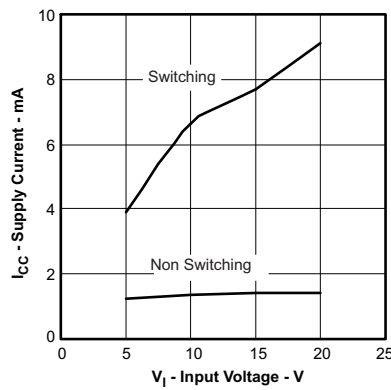

Figure 15.

DISABLED SUPPLY CURRENT
VS
INPUT VOLTAGE

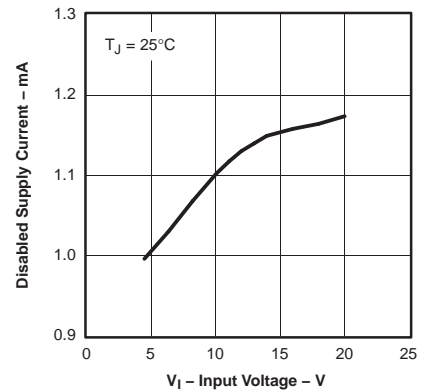

Figure 16.

BIAS VOLTAGE
VS
INPUT VOLTAGE

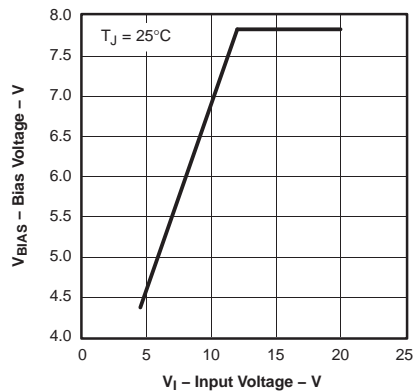

Figure 17.

POWER GOOD THRESHOLD
VS
JUNCTION TEMPERATURE

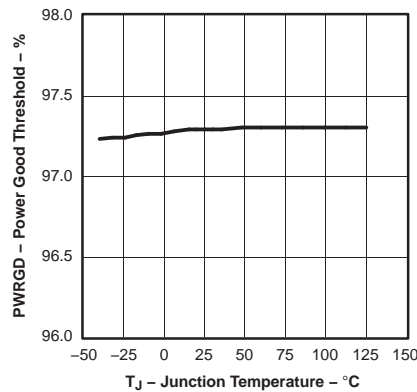

Figure 18.

POWER GOOD DELAY
VS
SWITCHING FREQUENCY

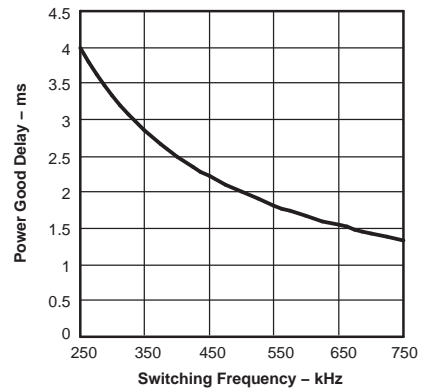

Figure 19.

PH VOLTAGE
VS
PH SINK CURRENT

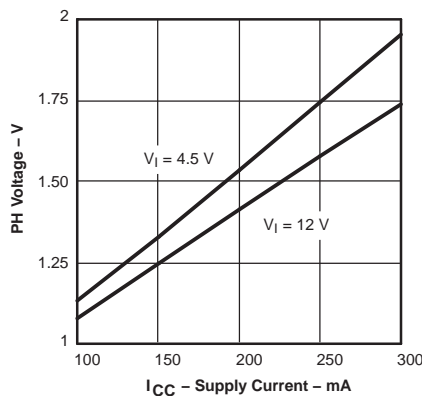

Figure 20.

SLOW START CAPACITANCE
VS
TIME

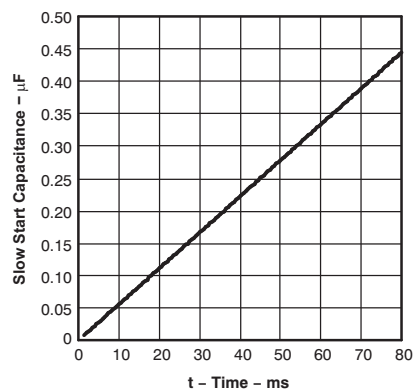

Figure 21.

INTERNAL SLOW START TIME
VS
SWITCHING FREQUENCY

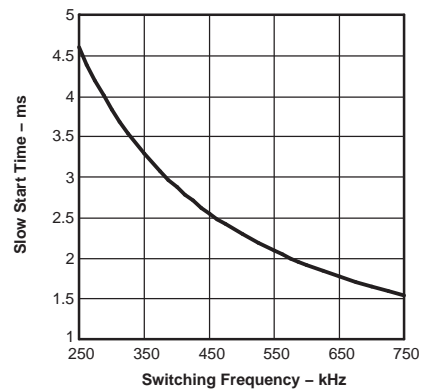

Figure 22.

TYPICAL CHARACTERISTICS (continued)

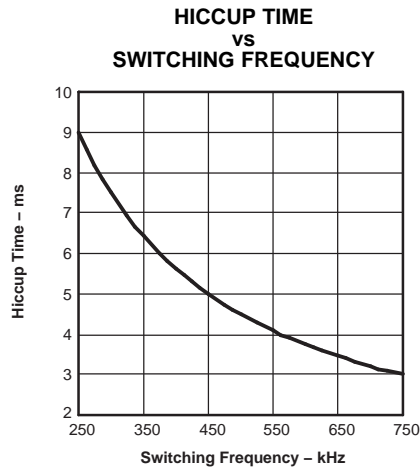

Figure 23.

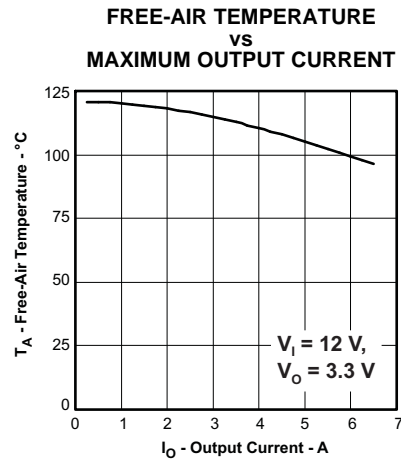

Figure 24.

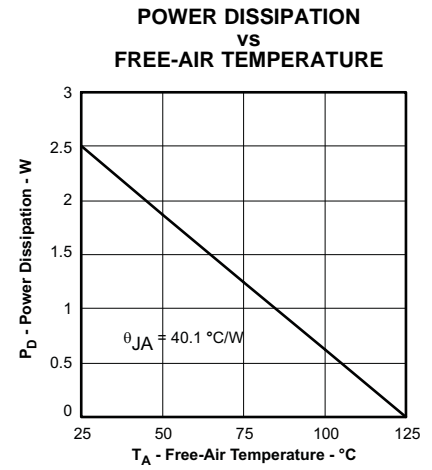

Figure 25.

APPLICATION INFORMATION

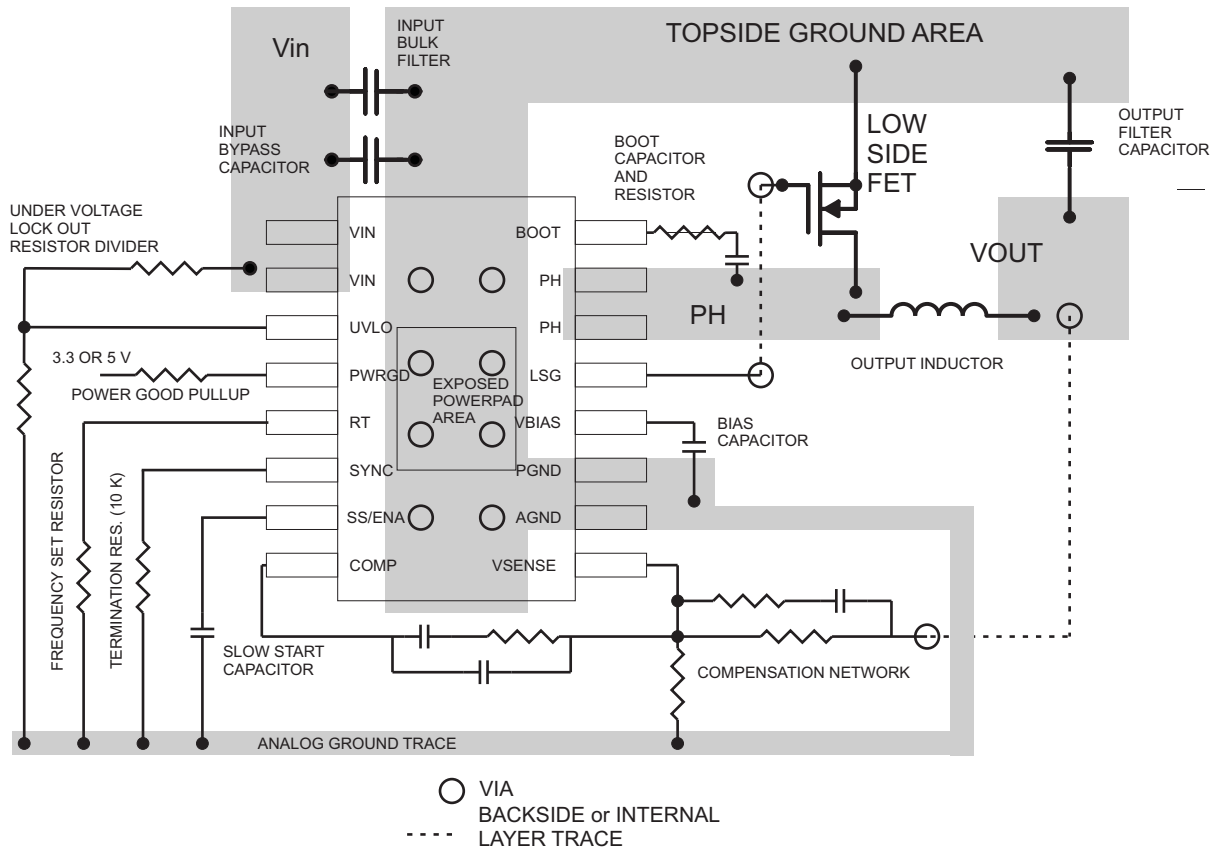

Figure 26. TPS54550 PCB Layout

PCB LAYOUT

The VIN pins should be connected together on the printed circuit board (PCB) and bypassed with a low ESR ceramic bypass capacitor. Care should be taken to minimize the loop area formed by the bypass capacitor connections, the VIN pins, and source of the low-side MOSFET. The minimum recommended bypass capacitance is 10- μ F ceramic with a X5R or X7R dielectric and the optimum placement is closest to the VIN pins and the source of the low-side MOSFET. See Figure 26 for a PCB layout example. The AGND and PGND pins should be tied to the PCB ground plane at the pins of the IC. The source of the low-side MOSFET should be connected directly to the PCB ground plane. The PH pins should be tied together and routed to the drain of the low-side MOSFET. Since the PH connection is the switching node, the MOSFET should be located very close to the PH pins, and the area of the PCB

conductor minimized to prevent excessive capacitive coupling. The recommended conductor width from pins 14 and 15 is 0.050 inch to 0.075 inch of 1-ounce to 2-ounce copper. The length of the copper land pattern should be no more than 0.2 inch.

For operation at full rated load, the analog ground plane must provide adequate heat dissipating area. A 3-inch by 3-inch plane of copper is recommended, though not mandatory, depending on ambient temperature and airflow. Most applications have larger areas of internal ground plane available, and the PowerPAD should be connected to the largest area available. Additional areas on the bottom or top layers also help dissipate heat, and any area available should be used when 5 A or greater operation is desired. Connection from the exposed area of the PowerPAD to the analog ground plane layer should be made using 0.013-inch diameter vias to avoid solder wicking through the vias. Four vias should be in the PowerPAD area with four additional vias outside the pad area and underneath the package. Additional vias beyond those recommended to enhance thermal performance should be included in areas not under the device package. See Figure 27.

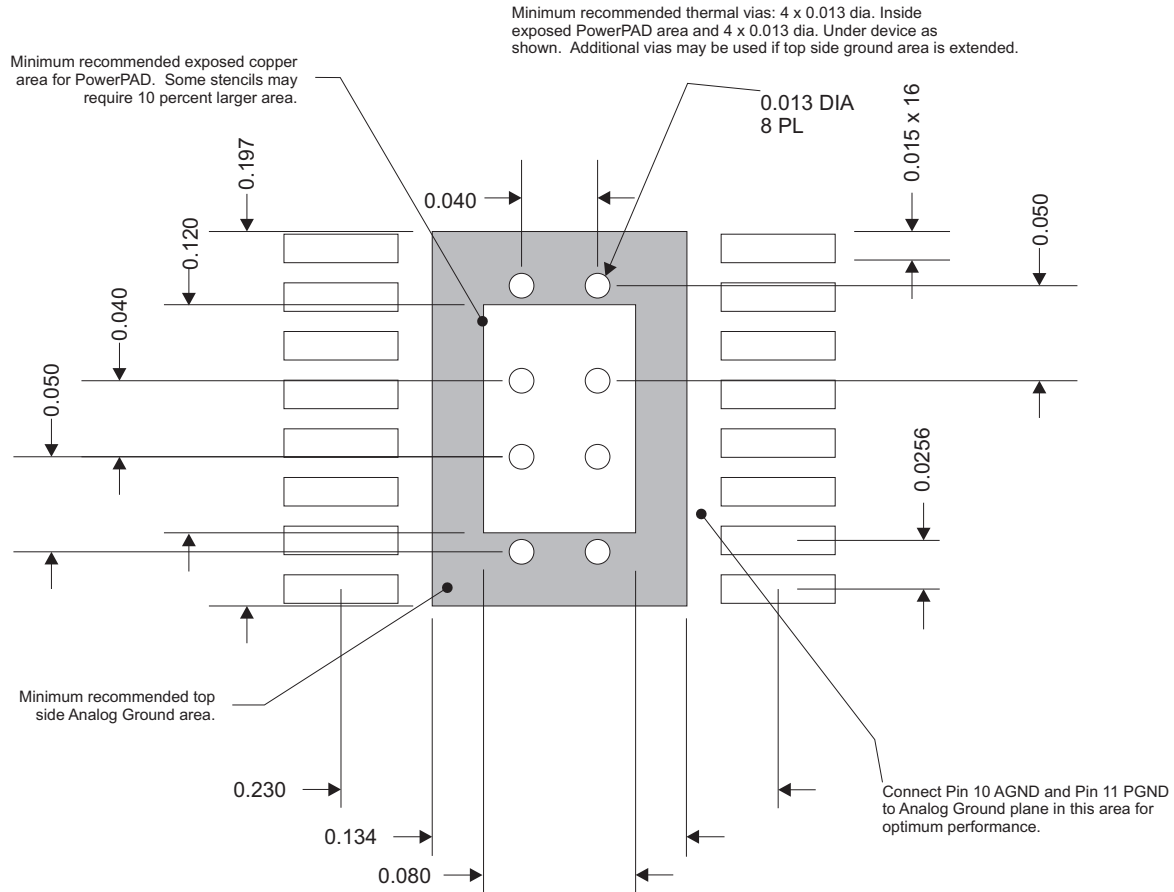

Figure 27. Thermal Considerations for PowerPAD Layout

MODEL FOR LOOP RESPONSE

Figure 28 shows an equivalent model for the TPS54550 control loop which can be modeled in a circuit simulation program to check frequency response and dynamic load response. The error amplifier in the TPS54550 is a voltage amplifier with 80 dB (10000 V/V) of open-loop gain. The error amplifier can be modeled using an ideal voltage-controlled current source as shown in Figure 28 with a resistor and capacitor on the output. The TPS54550 device has an integrated feed forward compensation circuit which eliminates the impact of the input voltage changes to the overall loop transfer function.

The feed forward gain is modeled as an ideal voltage- controlled voltage source with a gain of 8 V/V. The 1-mV ac voltage between nodes a and b effectively breaks the control loop for the frequency response measurements. Plotting b/c shows the small-signal response of the power stage. Plotting c/a shows the small-signal response of the frequency compensation. Plotting a/b shows the small-signal response of the overall loop. The dynamic load response can be checked by replacing the R_L with a current source with the appropriate load step amplitude and step rate in a time domain analysis.

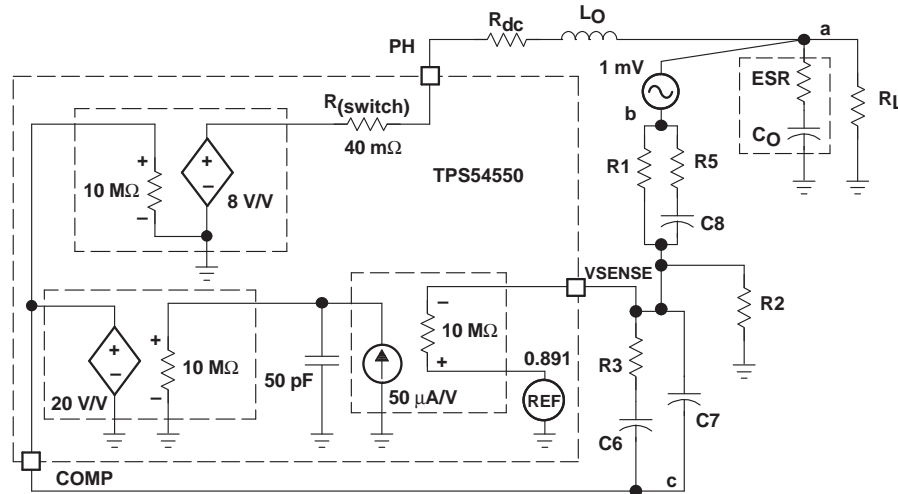

Figure 28. Model of Control Loop

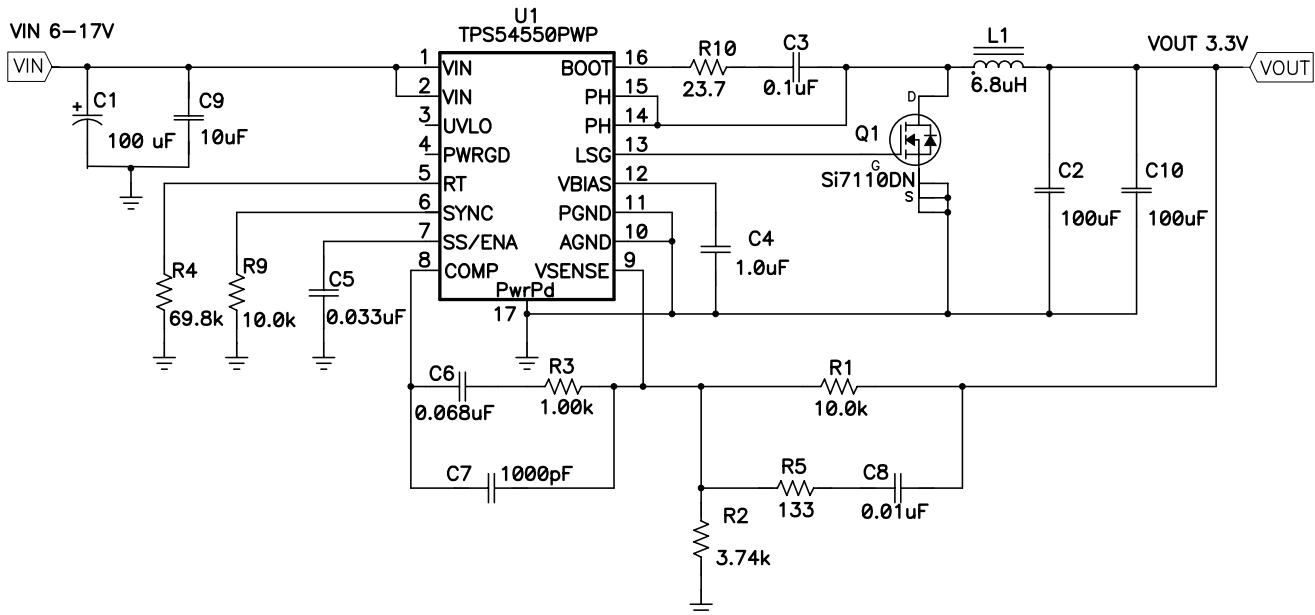

Figure 29. Application Circuit, 3.3 V Output

Figure 29 shows the schematic for a typical TPS54550 application. The TPS54550 can provide up to 5-A output current at a nominal output voltage of 3.3 V. For proper thermal performance, the exposed PowerPAD underneath the device must be soldered down to the printed circuit board.

DESIGN PROCEDURE

The following design procedure can be used to select component values for the TPS54550. Alternately, the SWIFT Designer Software may be used to generate a complete design. The SWIFT Designer Software uses an iterative design procedure and accesses a comprehensive database of components when generating a design. This section presents a simplified discussion of the design process.

To begin the design process a few parameters must be decided upon. The designer needs to know the following:

- Input voltage range
- Output voltage
- Input ripple voltage
- Output ripple voltage
- Output current rating
- Operating frequency

For this design example, use the following as the input parameters:

DESIGN PARAMETER	EXAMPLE VALUE
Input voltage range	6 V to 17 V
Output voltage	3.3 V
Input ripple voltage	300 mV
Output ripple voltage	30 mV
Output current rating	5 A
Operating frequency	700 kHz
NOTE: As an additional constraint, the design is set up to be small size and low component height.	

SWITCHING FREQUENCY

The switching frequency is set using the RT pin. Grounding the RT pin sets the PWM switching frequency to a default frequency of 250 kHz. Floating the RT pin sets the PWM switching frequency to 500 kHz. By connecting a resistor from RT to AGND, any frequency in the range of 250 to 700 kHz can be set. Use Equation 8 to determine the proper value of RT.

$$RT(k\Omega) = \frac{46000}{f_s(kHz) - 35.9} \quad (8)$$

In this example circuit, the desired switching frequency is 700 kHz and RT is 69.8 kΩ.

INPUT CAPACITORS

The TPS54550 requires an input decoupling capacitor and, depending on the application, a bulk input capacitor. The minimum recommended value for the decoupling capacitor, C9, is 10 μF. A high-quality ceramic type X5R or X7R is recommended. The voltage rating should be greater than the maximum input voltage. A smaller value may be used as long as all other requirements are met; however 10 μF has been shown to work well in a wide variety of circuits. Additionally, some bulk capacitance may be needed, especially if the TPS54550 circuit is not located within about 2 inches from the input voltage source. The value for this capacitor is not critical but should be rated to handle the maximum input voltage including ripple voltage, and should filter the output so that input ripple voltage is acceptable.

This input ripple voltage can be approximated by Equation 9:

$$\Delta V_{IN} = \frac{I_{OUT(MAX)} \times 0.25}{C_{BULK} \times f_{sw}} + (I_{OUT(MAX)} \times ESR_{MAX}) \quad (9)$$

Where $I_{OUT(MAX)}$ is the maximum load current, f_{sw} is the switching frequency, C_{BULK} is the bulk capacitor value and ESR_{MAX} is the maximum series resistance of the bulk capacitor.

The maximum RMS ripple current also needs to be checked. For worst case conditions, this can be approximated by Equation 10:

$$I_{CIN} = \frac{I_{OUT(MAX)}}{2} \quad (10)$$

In this case, the input ripple voltage would be 140 mV and the RMS ripple current would be 2.5 A. It is also important to note that the actual input voltage ripple will be greatly affected by parasitics associated with the layout and the output impedance of the voltage source. The actual input voltage ripple for this circuit is shown in Figure 34 and is larger than the calculated value. This measured value is still below the specified input limit of 300 mV. The maximum voltage across the input capacitors would be $V_{IN\ max}$ plus $\Delta V_{IN}/2$. The chosen bulk and bypass capacitors are each rated for 25 V and the combined ripple current capacity is greater than 3 A, both providing ample margin. It is very important that the maximum ratings for voltage and current are not exceeded under any circumstance.

OUTPUT FILTER COMPONENTS

Two components need to be selected for the output filter, L1 and C2. Since the TPS54550 is an externally compensated device, a wide range of filter component types and values can be supported.

Inductor Selection

To calculate the minimum value of the output inductor, use Equation 11:

$$L_{MIN} = \frac{V_{OUT(MAX)} \times (V_{IN(MAX)} - V_{OUT})}{V_{IN(max)} \times K_{IND} \times I_{OUT} \times F_{SW}} \quad (11)$$

K_{IND} is a coefficient that represents the amount of inductor ripple current relative to the maximum output current. In general, this value is at the discretion of the designer; however, the following guidelines may be used. For designs using low ESR output capacitors such as ceramics, a value as high as $K_{IND} = 0.3$ may be used. When using higher ESR output capacitors, $K_{IND} = 0.2$ yields better results.

For this design example, use $K_{IND} = 0.3$ and the minimum inductor value is calculated to be 3 μH. For this design, a large value was chosen: 6.8 μH.

For the output filter inductor, it is important that the RMS current and saturation current ratings not be exceeded. The RMS inductor current can be found from [Equation 12](#):

$$I_{L(RMS)} = \sqrt{I_{OUT(MAX)}^2 + \frac{1}{12} \times \left(\frac{V_{OUT} \times (V_{IN(MAX)} - V_{OUT})}{V_{IN(MAX)} \times L_{OUT} \times F_{SW} \times 0.8} \right)^2} \quad (12)$$

and the peak inductor current can be determined with [Equation 13](#):

$$I_{L(PK)} = I_{OUT(MAX)} + \frac{V_{OUT} \times (V_{IN(MAX)} - V_{OUT})}{1.6 \times V_{IN(MAX)} \times L_{OUT} \times F_{SW}} \quad (13)$$

For this design, the RMS inductor current is 5.04 A and the peak inductor current is 5.35 A. The chosen inductor is a Sumida CDRH105-6R8 6.8 μ H. It has a saturation current rating of 5.4 A and an RMS current rating of 5.4 A, meeting these requirements. A smaller value inductor could be used; however, this value was chosen because it has the largest value in this style that met the current rating requirements. Larger value inductors will have lower ac current and result in lower output voltage ripple. In general, inductor values for use with the TPS54550 are in the range of 6.8 μ H to 47 μ H.

Capacitor Selection

The important design factors for the output capacitor are dc voltage rating, ripple current rating, and equivalent series resistance (ESR). The dc voltage and ripple current ratings cannot be exceeded. The ESR is important because along with the inductor current it determines the amount of output ripple voltage. The actual value of the output capacitor is not critical, but some practical limits do exist. Consider the relationship between the desired closed loop crossover frequency of the design and LC corner frequency of the output filter. In general, it is desirable to keep the closed loop crossover frequency at less than 1/5 of the switching frequency. With high switching frequencies such as the 700-kHz frequency of this design, internal circuit limitations of the TPS54550 limit the practical maximum crossover frequency to about 50 kHz. Additionally, to allow for adequate phase gain in the compensation network, the closed loop crossover frequency should be at least 30% higher than the LC corner frequency. This limits the minimum capacitor value for the output filter to:

$$C_{OUT} = \frac{1}{L_{OUT}} \times \left(\frac{K}{2\pi f_{CO}} \right)^2 \quad (14)$$

Where K is the frequency multiplier for the spread between f_{LC} and f_{CO} . K should be between 1.3 and 15, typically 10 for one decade difference. For a desired crossover of 13 kHz and a 6.8- μ H inductor, the minimum value for the output capacitor is around

39 μ F. In this design a more conservative frequency multiplier of 3 is used, resulting in a desired output capacitance of 200 μ F. The selected output capacitor must be rated for a voltage greater than the desired output voltage plus 1/2 the ripple voltage. Any derating amount must also be included. The maximum RMS ripple current in the output capacitor is given by [Equation 15](#):

$$I_{COUT(RMS)} = \frac{1}{\sqrt{12}} \times \left[\frac{V_{OUT} \times (V_{IN(MAX)} - V_{OUT})}{V_{IN(MAX)} \times L_{OUT} \times F_{SW} \times N_C} \right] \quad (15)$$

Where N_C is the number of output capacitors in parallel.

The maximum ESR of the output capacitor is determined by the amount of allowable output ripple as specified in the initial design parameters. The output ripple voltage is the inductor ripple current times the ESR of the output filter, so the maximum specified ESR as listed in the capacitor data sheet is given by [Equation 16](#):

$$ESR_{MAX} = N_C \times \left(\frac{V_{IN(MAX)} \times L_{OUT} \times F_{SW} \times 0.8}{V_{OUT} \times (V_{IN(MAX)} - V_{OUT})} \right) \times \Delta V_{p-p(MAX)} \quad (16)$$

Where ΔV_{p-p} is the desired peak-to-peak output ripple. For this design example, two 100- μ F ceramic output capacitors are chosen for C2 and C10. These are TDK C3225X5R0J107M, rated at 6.3 V with a maximum ESR of 2 m Ω and a ripple current rating in excess of 3 A. The calculated total RMS ripple current is 161 mA (80.6 mA each) and the maximum total ESR required is 43 m Ω . These output capacitors exceed the requirements by a wide margin and will result in a reliable, high-performance design. It is important to note that the actual capacitance in circuit may be less than the catalog value when the output is operating at the desired output of 3.3 V.

Other capacitor types work well with the TPS54550, depending on the needs of the application.

COMPENSATION COMPONENTS

The external compensation used with the TPS54550 allows for a wide range of output filter configurations. A large range of capacitor values and types of dielectric are supported. The design example uses Type 3 compensation consisting of R1, R3, R5, C6, C7, and C8. Additionally, R2 along with R1 forms a voltage divider network that sets the output voltage. These component reference designators are the same as those used in the SWIFT Designer Software. There are a number of different ways to design a compensation network. This procedure outlines a relatively simple procedure that produces good results with most output filter combinations.

Use of the SWIFT Designer Software is recommended for designs with unusually high closed loop crossover frequencies, low value, low ESR output capacitors such as ceramics, or if the designer is unsure about the design procedure.

When designing compensation networks for the TPS54550, a number of factors need to be considered. The gain of the compensated error amplifier should not be limited by the open-loop amplifier gain characteristics and should not produce excessive gain at the switching frequency. Also, the closed loop crossover frequency should be set less than 1/5 of the switching frequency, and the phase margin at crossover must be greater than 45 degrees. The general procedure outlined here produces results consistent with these requirements without going into great detail about the theory of loop compensation.

First, calculate the output filter LC corner frequency using [Equation 17](#):

$$f_{LC} = \frac{1}{2\pi \sqrt{L_{OUT}C_{OUT}}} \quad (17)$$

For the design example, $f_{LC} = 4315$ Hz.

The closed loop crossover frequency should be greater than f_{LC} and less than 1/5 of the switching frequency. Also, the crossover frequency should not exceed 50 kHz, as the error amplifier may not provide the desired gain. For this design, a crossover frequency of 13 kHz was chosen. This value is chosen for comparatively wide loop bandwidth while still allowing for adequate phase boost to insure stability.

Next, calculate the R2 resistor value for the output voltage of 3.3 V using [Equation 18](#):

$$R2 = \frac{R1 \times 0.891}{V_{OUT} - 0.891} \quad (18)$$

For any TPS54550 design, start with an R1 value of 1.0 k Ω . R2 is then 374 Ω .

Now the values for the compensation components that set the poles and zeroes of the compensation network can be calculated. Assuming that $R1 > R5$ and $C6 > C7$, the pole and zero locations are given by [Equation 19](#) through [Equation 22](#):

$$f_{Z1} = \frac{1}{2\pi R3C6} \quad (19)$$

$$f_{Z2} = \frac{1}{2\pi R1C8} \quad (20)$$

$$f_{P1} = \frac{1}{2\pi R5C8} \quad (21)$$

$$f_{P2} = \frac{1}{2\pi R3C7} \quad (22)$$

Additionally, there is a pole at the origin, which has unity gain with the following frequency:

$$f_{INT} = \frac{1}{2\pi R1C6} \quad (23)$$

This pole is used to set the overall gain of the compensated error amplifier and determines the closed loop crossover frequency.

There are a number of popular ways to design Type 3 compensation networks. The theory behind these calculations is beyond the scope of this document. It is always best to use any calculated compensation values as the basis for an initial design, and then verify the actual closed loop response. The initial values may then be adjusted to suit the individual design requirements. The SWIFT software design tool can also be used to provide an initial circuit design.

In this circuit, the first compensation zero was set at approximately 1/2 the LC corner frequency, with the second zero slightly below that to increase the phase gain prior to the double pole of the LC output filter. At the LC corner frequency, the overall phase response rapidly drops by 180 degrees, so it is important to increase the initial phase of 90 degrees prior to the LC corner.

The two compensation poles are set high enough to not cause loss of phase margin at the closed loop cross over and low enough to not cause the error amplifier gain to exceed the unity gain bandwidth limit of the internal operational amplifier. The integrator frequency is then chosen to set the overall gain and crossover frequency.

This results in the following pole and zero frequencies:

$$f_{Z1} = 2340 \text{ Hz}$$

$$f_{Z2} = 1591 \text{ Hz}$$

$$f_{P1} = 120 \text{ kHz}$$

$$f_{P2} = 159 \text{ kHz}$$

$$f_{INT} = 234 \text{ Hz}$$

The measured overall loop response for the circuit is given in [Figure 5](#). Note that the actual closed loop crossover frequency is higher than intended at about 25 kHz. This is primarily due to variation in the actual values of the output filter components and tolerance variation of the internal feedforward gain circuitry. Overall the design has greater than 60 degrees of phase margin and will be completely stable over all combinations of line and load variability.

Since R1 is given as 10 k Ω and the crossover frequency is selected as 13 kHz, the desired f_{INT} can be calculated with [Equation 24](#):

$$f_{INT} = \frac{10^{-0.9} \times f_{CO}}{2} \quad (24)$$

And the value for C6 is given by [Equation 25](#):

$$C6 = \frac{1}{2\pi R1 f_{INT}} \quad (25)$$

The first zero, f_{z1} , is located at 1/2 the output filter LC corner frequency, so R3 can be calculated from [Equation 26](#):

$$R3 = \frac{1}{\pi C6 f_{LC}} \quad (26)$$

The second zero, f_{z2} , is located at the output filter LC corner frequency, so C8 can be calculated from [Equation 27](#):

$$C8 = \frac{1}{2\pi R1 f_{LC}} \quad (27)$$

The first pole, f_{p1} , is located to coincide with the output filter ESR zero frequency. This frequency is given by [Equation 28](#):

$$f_{ESR} = \frac{1}{2\pi R_{ESR} C_{OUT}} \quad (28)$$

where R_{ESR} is the equivalent series resistance of the output capacitor.

In this case, the ESR zero frequency is 35.4 kHz, and R5 can be calculated from [Equation 29](#):

$$R5 = \frac{1}{2\pi C8 f_{ESR}} \quad (29)$$

The final pole is placed at a frequency above the closed loop crossover frequency high enough to not cause the phase to decrease too much at the crossover frequency while still providing enough attenuation so that there is little or no gain at the switching frequency. The f_{p2} pole location for this circuit is set to 4 times the closed loop crossover frequency. The last compensation component value C7 can be derived from [Equation 30](#):

$$C7 = \frac{1}{8\pi R3 f_{CO}} \quad (30)$$

Note that capacitors are only available in a limited range of standard values, so the nearest standard value has been chosen for each capacitor. The measured closed loop response for this design is shown in [Figure 30](#).

BIAS AND BOOTSTRAP CAPACITORS

Every TPS54550 design requires a bootstrap capacitor, C3 and a bias capacitor, C4. The bootstrap capacitor must be 0.1 μ F. The bootstrap capacitor is located between the PH pins and BOOT pin. In addition, a 24- Ω resistor is placed in series with the bootstrap capacitor. This resistor is used to slow down the leading edge of the high-side FET turn on waveform. Using this resistor will dramatically decrease the amplitude of the overshoot on the switching node. The bias capacitor is connected between the VBIAS pin and AGND. The value should be 1.0 μ F. Both capacitors should be high-quality ceramic types with X7R or X5R grade dielectric for temperature stability. They should be placed as close to the device connection pins as possible.

LOW-SIDE FET

The TPS54550 is designed to operate using an external low-side FET, and the LSG pin provides the gate drive output. Connect the drain to the PH pin, the source to PGND, and the gate to LSG. The TPS54550 gate drive circuitry is designed to accommodate most common n-channel FETs that are suitable for this application. The SWIFT Designer Software can be used to calculate all the design parameters for low-side FET selection. There are some simplified guidelines that can be applied that produce an acceptable solution in most designs.

The selected FET must meet the absolute maximum ratings for the application:

Drain-source voltage (V_{DS}) must be higher than the maximum voltage at the PH pin, which is $V_{INMAX} + 0.5$ V.

Gate-source voltage (V_{GS}) must be greater than 8 V.

Drain current (I_D) must be greater than $1.1 \times I_{OUTMAX}$.

Drain-source on resistance ($r_{DS(on)}$) should be as small as possible, less than 30 m Ω is desirable. Lower values for $r_{DS(on)}$ result in designs with higher efficiencies. It is important to note that the low-side FET on time is typically longer than the high-side FET on time, so attention paid to low-side FET parameters can make a marked improvement in overall efficiency.

Total gate charge (Q_g) must be less than 50 nC. Again, lower Q_g characteristics result in higher efficiencies.

Additionally, check that the device chosen is capable of dissipating the power losses.

For this design, a Vishay Siliconix SI7110 20-V n-channel MOSFET is used as the low-side FET. This particular FET is specifically designed to be used as a low-side synchronous rectifier.

POWER GOOD

The TPS54550 is provided with a power good output pin PWRGD. This output is an open drain output and is intended to be pulled up to a 3.3-V or 5-V logic supply. A 10-k Ω pull-up resistor works well in this application. The absolute maximum voltage is 6 V, so care must be taken not to connect this pull-up resistor to VIN if the maximum input voltage exceeds 6 V.

APPLICATION CURVES (see Figure 29)

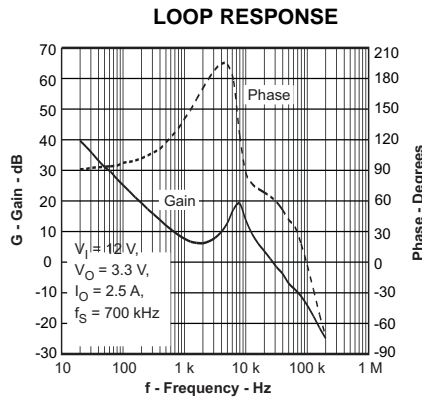

Figure 30.

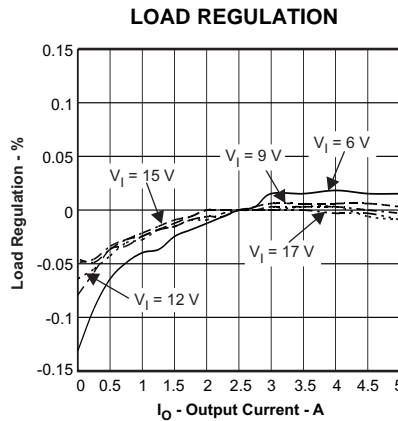

Figure 31.

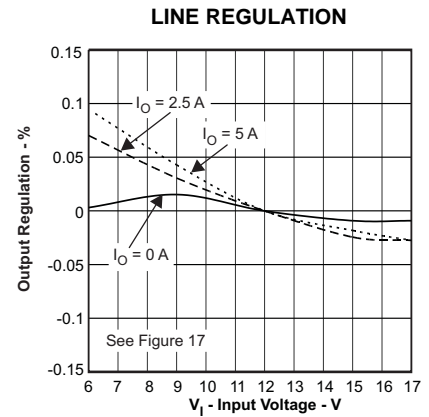

Figure 32.

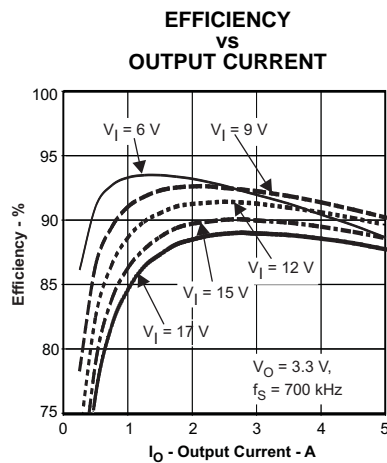

Figure 33.

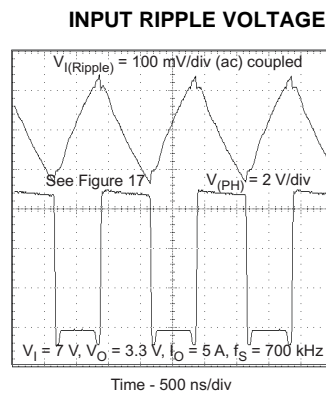

Figure 34.

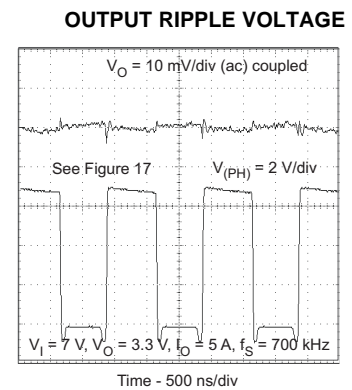

Figure 35.

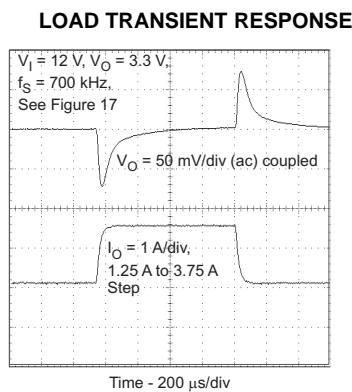

Figure 36.

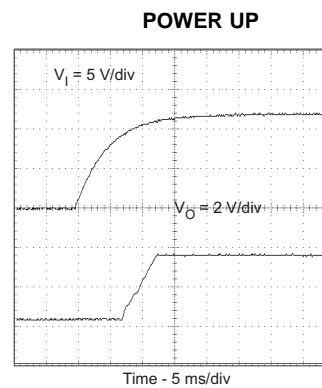

Figure 37.

PACKAGING INFORMATION

Orderable Device	Status ⁽¹⁾	Package Type	Package Drawing	Pins	Package Qty	Eco Plan ⁽²⁾	Lead/Ball Finish	MSL Peak Temp ⁽³⁾
TPS54550PWP	ACTIVE	HTSSOP	PWP	16	90	Green (RoHS & no Sb/Br)	CU NIPDAU	Level-2-260C-1 YEAR
TPS54550PWPG4	ACTIVE	HTSSOP	PWP	16	90	Green (RoHS & no Sb/Br)	CU NIPDAU	Level-2-260C-1 YEAR
TPS54550PWPR	ACTIVE	HTSSOP	PWP	16	2000	Green (RoHS & no Sb/Br)	CU NIPDAU	Level-2-260C-1 YEAR
TPS54550PWPRG4	ACTIVE	HTSSOP	PWP	16	2000	Green (RoHS & no Sb/Br)	CU NIPDAU	Level-2-260C-1 YEAR

⁽¹⁾ The marketing status values are defined as follows:

ACTIVE: Product device recommended for new designs.

LIFEBUY: TI has announced that the device will be discontinued, and a lifetime-buy period is in effect.

NRND: Not recommended for new designs. Device is in production to support existing customers, but TI does not recommend using this part in a new design.

PREVIEW: Device has been announced but is not in production. Samples may or may not be available.

OBSOLETE: TI has discontinued the production of the device.

⁽²⁾ Eco Plan - The planned eco-friendly classification: Pb-Free (RoHS), Pb-Free (RoHS Exempt), or Green (RoHS & no Sb/Br) - please check <http://www.ti.com/productcontent> for the latest availability information and additional product content details.

TBD: The Pb-Free/Green conversion plan has not been defined.

Pb-Free (RoHS): TI's terms "Lead-Free" or "Pb-Free" mean semiconductor products that are compatible with the current RoHS requirements for all 6 substances, including the requirement that lead not exceed 0.1% by weight in homogeneous materials. Where designed to be soldered at high temperatures, TI Pb-Free products are suitable for use in specified lead-free processes.

Pb-Free (RoHS Exempt): This component has a RoHS exemption for either 1) lead-based flip-chip solder bumps used between the die and package, or 2) lead-based die adhesive used between the die and leadframe. The component is otherwise considered Pb-Free (RoHS compatible) as defined above.

Green (RoHS & no Sb/Br): TI defines "Green" to mean Pb-Free (RoHS compatible), and free of Bromine (Br) and Antimony (Sb) based flame retardants (Br or Sb do not exceed 0.1% by weight in homogeneous material)

⁽³⁾ MSL, Peak Temp. -- The Moisture Sensitivity Level rating according to the JEDEC industry standard classifications, and peak solder temperature.

Important Information and Disclaimer:The information provided on this page represents TI's knowledge and belief as of the date that it is provided. TI bases its knowledge and belief on information provided by third parties, and makes no representation or warranty as to the accuracy of such information. Efforts are underway to better integrate information from third parties. TI has taken and continues to take reasonable steps to provide representative and accurate information but may not have conducted destructive testing or chemical analysis on incoming materials and chemicals. TI and TI suppliers consider certain information to be proprietary, and thus CAS numbers and other limited information may not be available for release.

In no event shall TI's liability arising out of such information exceed the total purchase price of the TI part(s) at issue in this document sold by TI to Customer on an annual basis.

TAPE AND REEL INFORMATION



QUADRANT ASSIGNMENTS FOR PIN 1 ORIENTATION IN TAPE



*All dimensions are nominal

Device	Package Type	Package Drawing	Pins	SPQ	Reel Diameter (mm)	Reel Width W1 (mm)	A0 (mm)	B0 (mm)	K0 (mm)	P1 (mm)	W (mm)	Pin1 Quadrant
TPS54550PWPR	HTSSOP	PWP	16	2000	330.0	12.4	6.67	5.4	1.6	8.0	12.0	Q1

TAPE AND REEL BOX DIMENSIONS



*All dimensions are nominal

Device	Package Type	Package Drawing	Pins	SPQ	Length (mm)	Width (mm)	Height (mm)
TPS54550PWPR	HTSSOP	PWP	16	2000	346.0	346.0	29.0

PWP (R-PDSO-G**) 20 PIN SHOWN

PowerPAD™ PLASTIC SMALL-OUTLINE PACKAGE

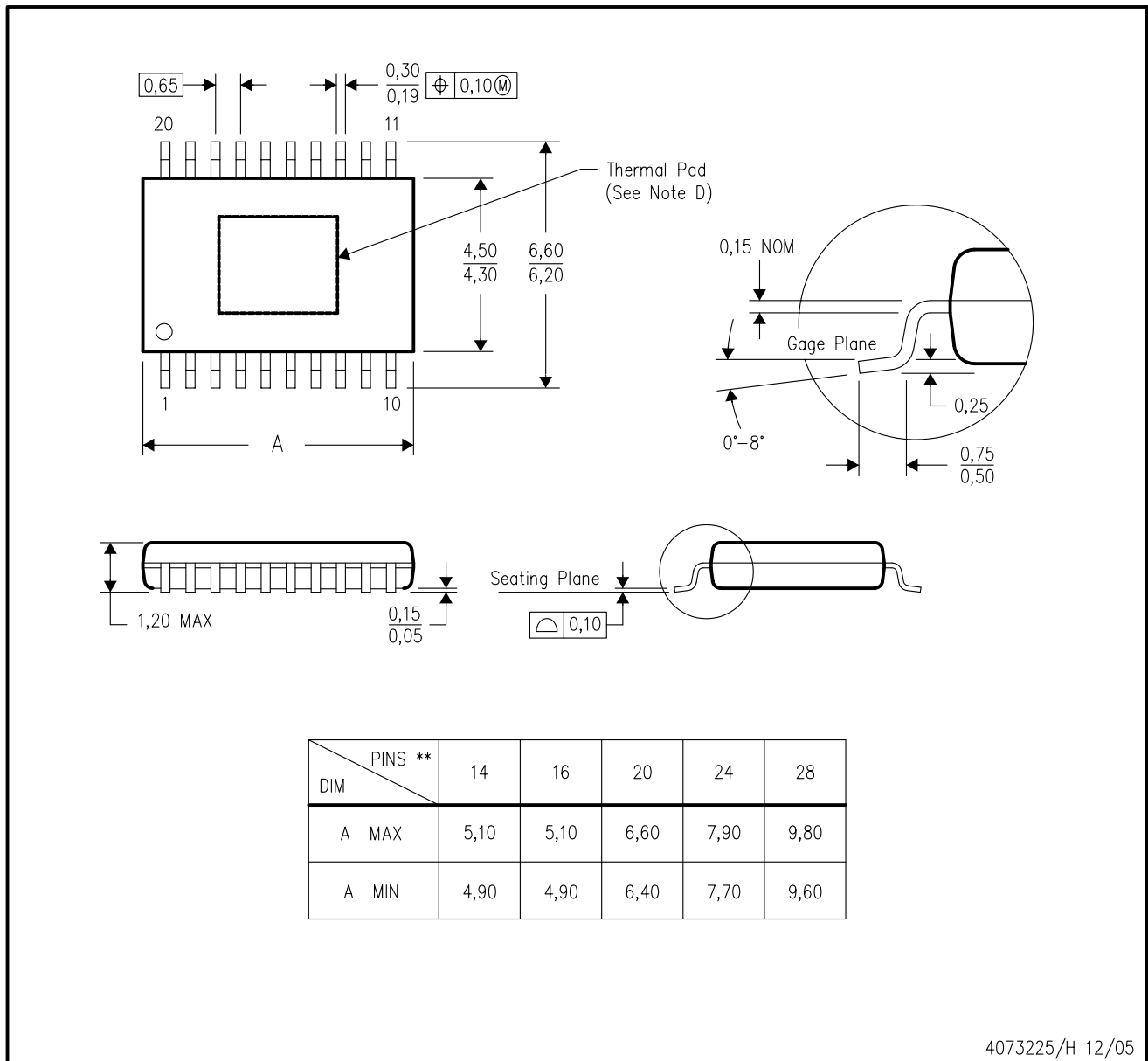

4073225/H 12/05

- NOTES:
- A. All linear dimensions are in millimeters.
 - B. This drawing is subject to change without notice.
 - C. Body dimensions do not include mold flash or protrusions. Mold flash and protrusion shall not exceed 0.15 per side.
 - D. This package is designed to be soldered to a thermal pad on the board. Refer to Technical Brief, PowerPad Thermally Enhanced Package, Texas Instruments Literature No. SLMA002 for information regarding recommended board layout. This document is available at www.ti.com <<http://www.ti.com>>.
 - E. Falls within JEDEC MO-153

PowerPAD is a trademark of Texas Instruments.

THERMAL INFORMATION

This PowerPAD™ package incorporates an exposed thermal pad that is designed to be attached to a printed circuit board (PCB). The thermal pad must be soldered directly to the PCB. After soldering, the PCB can be used as a heatsink. In addition, through the use of thermal vias, the thermal pad can be attached directly to the appropriate copper plane shown in the electrical schematic for the device, or alternatively, can be attached to a special heatsink structure designed into the PCB. This design optimizes the heat transfer from the integrated circuit (IC).

For additional information on the PowerPAD package and how to take advantage of its heat dissipating abilities, refer to Technical Brief, PowerPAD Thermally Enhanced Package, Texas Instruments Literature No. SLMA002 and Application Brief, PowerPAD Made Easy, Texas Instruments Literature No. SLMA004. Both documents are available at www.ti.com.

The exposed thermal pad dimensions for this package are shown in the following illustration.

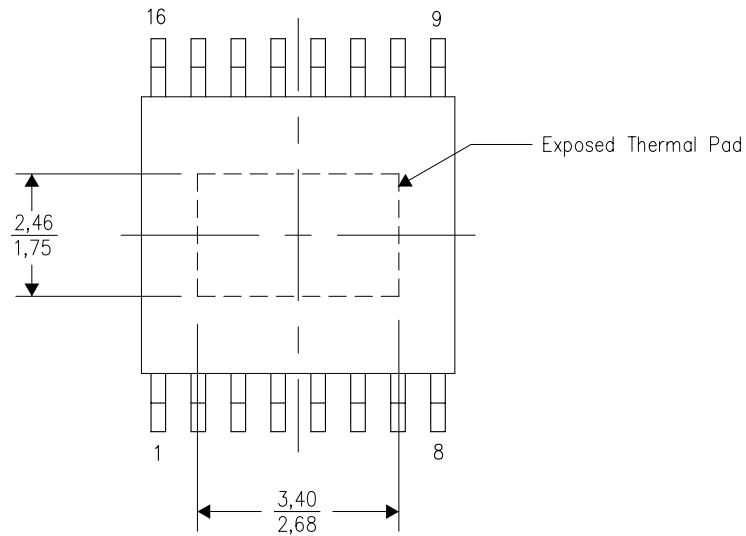

Top View

NOTE: All linear dimensions are in millimeters

Exposed Thermal Pad Dimensions

PWP (R-PDSO-G16) PowerPAD™

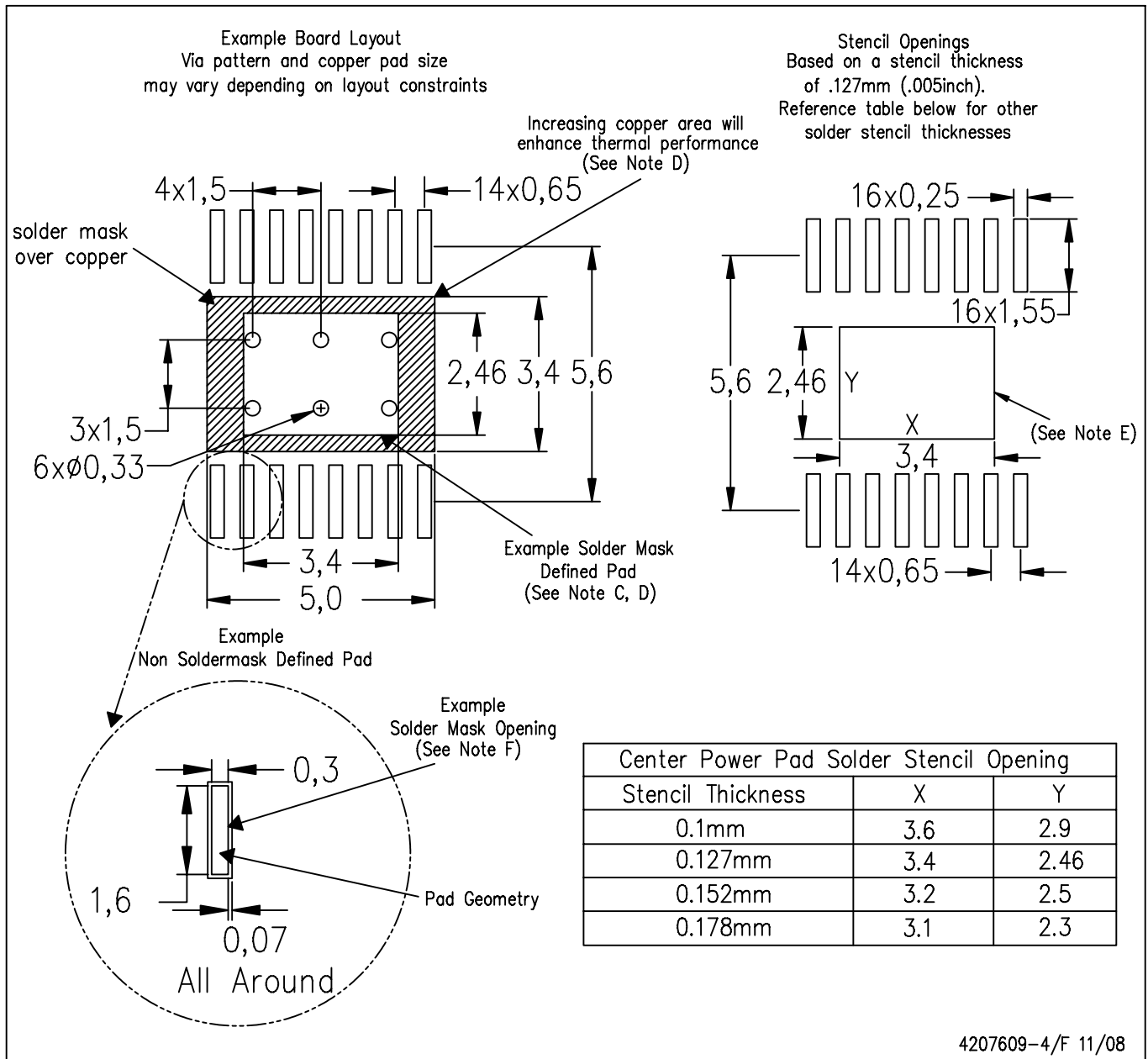

4207609-4/F 11/08

- NOTES:
- All linear dimensions are in millimeters.
 - This drawing is subject to change without notice.
 - Customers should place a note on the circuit board fabrication drawing not to alter the center solder mask defined pad.
 - This package is designed to be soldered to a thermal pad on the board. Refer to Technical Brief, PowerPad Thermally Enhanced Package, Texas Instruments Literature No. SLMA002, SLMA004, and also the Product Data Sheets for specific thermal information, via requirements, and recommended board layout. These documents are available at www.ti.com <<http://www.ti.com>>. Publication IPC-7351 is recommended for alternate designs.
 - Laser cutting apertures with trapezoidal walls and also rounding corners will offer better paste release. Customers should contact their board assembly site for stencil design recommendations. Example stencil design based on a 50% volumetric metal load solder paste. Refer to IPC-7525 for other stencil recommendations.
 - Customers should contact their board fabrication site for solder mask tolerances between and around signal pads.

PowerPAD is a trademark of Texas Instruments.

IMPORTANT NOTICE

Texas Instruments Incorporated and its subsidiaries (TI) reserve the right to make corrections, modifications, enhancements, improvements, and other changes to its products and services at any time and to discontinue any product or service without notice. Customers should obtain the latest relevant information before placing orders and should verify that such information is current and complete. All products are sold subject to TI's terms and conditions of sale supplied at the time of order acknowledgment.

TI warrants performance of its hardware products to the specifications applicable at the time of sale in accordance with TI's standard warranty. Testing and other quality control techniques are used to the extent TI deems necessary to support this warranty. Except where mandated by government requirements, testing of all parameters of each product is not necessarily performed.

TI assumes no liability for applications assistance or customer product design. Customers are responsible for their products and applications using TI components. To minimize the risks associated with customer products and applications, customers should provide adequate design and operating safeguards.

TI does not warrant or represent that any license, either express or implied, is granted under any TI patent right, copyright, mask work right, or other TI intellectual property right relating to any combination, machine, or process in which TI products or services are used. Information published by TI regarding third-party products or services does not constitute a license from TI to use such products or services or a warranty or endorsement thereof. Use of such information may require a license from a third party under the patents or other intellectual property of the third party, or a license from TI under the patents or other intellectual property of TI.

Reproduction of TI information in TI data books or data sheets is permissible only if reproduction is without alteration and is accompanied by all associated warranties, conditions, limitations, and notices. Reproduction of this information with alteration is an unfair and deceptive business practice. TI is not responsible or liable for such altered documentation. Information of third parties may be subject to additional restrictions.

Resale of TI products or services with statements different from or beyond the parameters stated by TI for that product or service voids all express and any implied warranties for the associated TI product or service and is an unfair and deceptive business practice. TI is not responsible or liable for any such statements.

TI products are not authorized for use in safety-critical applications (such as life support) where a failure of the TI product would reasonably be expected to cause severe personal injury or death, unless officers of the parties have executed an agreement specifically governing such use. Buyers represent that they have all necessary expertise in the safety and regulatory ramifications of their applications, and acknowledge and agree that they are solely responsible for all legal, regulatory and safety-related requirements concerning their products and any use of TI products in such safety-critical applications, notwithstanding any applications-related information or support that may be provided by TI. Further, Buyers must fully indemnify TI and its representatives against any damages arising out of the use of TI products in such safety-critical applications.

TI products are neither designed nor intended for use in military/aerospace applications or environments unless the TI products are specifically designated by TI as military-grade or "enhanced plastic." Only products designated by TI as military-grade meet military specifications. Buyers acknowledge and agree that any such use of TI products which TI has not designated as military-grade is solely at the Buyer's risk, and that they are solely responsible for compliance with all legal and regulatory requirements in connection with such use.

TI products are neither designed nor intended for use in automotive applications or environments unless the specific TI products are designated by TI as compliant with ISO/TS 16949 requirements. Buyers acknowledge and agree that, if they use any non-designated products in automotive applications, TI will not be responsible for any failure to meet such requirements.

Following are URLs where you can obtain information on other Texas Instruments products and application solutions:

Products

Amplifiers	amplifier.ti.com
Data Converters	dataconverter.ti.com
DSP	dsp.ti.com
Clocks and Timers	www.ti.com/clocks
Interface	interface.ti.com
Logic	logic.ti.com
Power Mgmt	power.ti.com
Microcontrollers	microcontroller.ti.com
RFID	www.ti-rfid.com
RF/IF and ZigBee® Solutions	www.ti.com/lprf

Applications

Audio	www.ti.com/audio
Automotive	www.ti.com/automotive
Broadband	www.ti.com/broadband
Digital Control	www.ti.com/digitalcontrol
Medical	www.ti.com/medical
Military	www.ti.com/military
Optical Networking	www.ti.com/opticalnetwork
Security	www.ti.com/security
Telephony	www.ti.com/telephony
Video & Imaging	www.ti.com/video
Wireless	www.ti.com/wireless

Mailing Address: Texas Instruments, Post Office Box 655303, Dallas, Texas 75265
Copyright © 2008, Texas Instruments Incorporated